



when it really counts

**INDIVIDUAL SOLUTIONS
FOR INDUSTRY.**



metabo®
PROFESSIONAL POWER TOOL SOLUTIONS

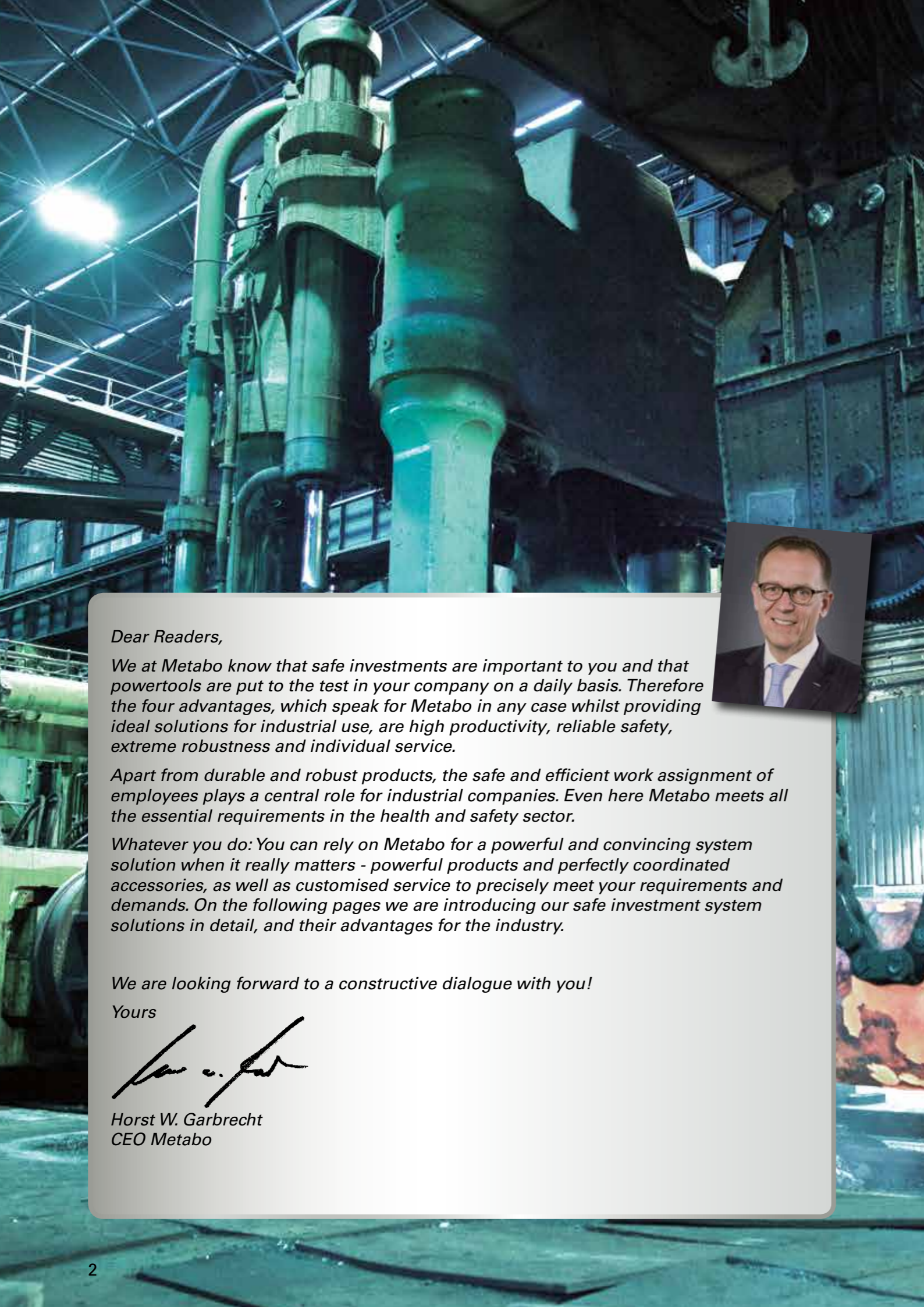

A STRONG PARTNER OF INDUSTRY IN MANY SECTORS WORLDWIDE.

Every Metabo product contains innovative engineering skills from Nürtingen, Germany. For more than 90 years, we have been developing innovative ideas and have been implementing them on site in pioneering system solutions and optimum accessories – especially also for individual industrial applications.

SOME OF THE INDUSTRIES IN WHICH WE HAVE BEEN ACTIVE FOR MANY YEARS:

Dear Readers,

We at Metabo know that safe investments are important to you and that power tools are put to the test in your company on a daily basis. Therefore the four advantages, which speak for Metabo in any case whilst providing ideal solutions for industrial use, are high productivity, reliable safety, extreme robustness and individual service.

Apart from durable and robust products, the safe and efficient work assignment of employees plays a central role for industrial companies. Even here Metabo meets all the essential requirements in the health and safety sector.

Whatever you do: You can rely on Metabo for a powerful and convincing system solution when it really matters - powerful products and perfectly coordinated accessories, as well as customised service to precisely meet your requirements and demands. On the following pages we are introducing our safe investment system solutions in detail, and their advantages for the industry.

We are looking forward to a constructive dialogue with you!

Yours

Horst W. Garbrecht
CEO Metabo



Mechanical engineering



Ship construction



Offshore



Industrial maintenance
Industry services

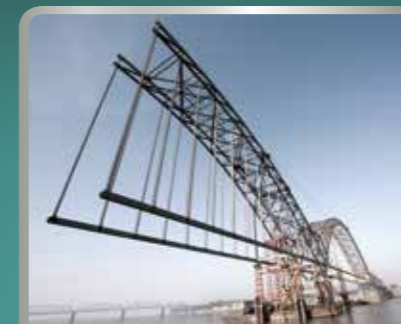

Steel construction



Wind power



Special vehicle manufacturing



Plant engineering



Power plant construction
and maintenance

INCREASE YOUR PRODUCTIVITY: WITH RELIABLE SYSTEM SOLUTIONS.

Metabo system solutions are developed by professionals for professionals, and thus meet even the highest demands and toughest conditions. Being a specialist for the metal trade, the metal processing industry and industrial maintenance, we offer a comprehensive range of products with integrated solutions for professional requirements in the three areas of: Drilling and screwdriving, cutting and grinding and of course sawing.



Apart from a number of mains-powered and compressed air solutions, almost every other solution from Metabo is available in a battery pack-powered format. This provides you with independence from the mains and cable.

For continuous productivity and reliability: Metabo offers system accessories and consumables that are optimally adapted to the machines.

The process safety provided by reliable tools is of top priority, especially in industrial environments. Metabo offers competent advice as well as customised service or product solutions.

Your benefits

Only Metabo offers you this added value:

- high-grade quality products "Made in Germany" from professionals for professionals
- individual system solutions for different requirements
- powerful tools for use under the harshest of conditions
- complete provider with perfectly coordinated system accessories and consumables
- greatest solution competency thanks to application analysis and product advice on site



Drilling and screwdriving

Drilling and screwdriving plays an important role both in metal processing and for assembly or maintenance tasks.

Thanks to Metabo's comprehensive range, from the bench drilling machine to the combination hammer, you are perfectly prepared for all jobs indoors or on external worksites. Naturally, a cordless version of almost all tools is available for mobile use.



Cutting and grinding

Particularly important in metal processing are the applications relating to cutting, grinding and polishing. For this purpose, we offer our customers an extensive range of compact and large angle grinders to meet all requirements and compliance in terms of safety, performance and handling.

Our cordless angle grinders are suitable for continuous industrial use thanks to our sophisticated battery pack technology.



Sawing

Our varied and extensive product range also leaves no demands unfulfilled when it comes to sawing.

Are you looking for powerful jigsaws, circular saws or cordless sabre saws for demanding applications on site?

Then you can be sure: Metabo delivers the right tool for almost any task.

SIMPLY KNOW THAT EVERY IMPORTANT ASPECT IS RIGHT: FOUR GOOD ARGUMENTS IN FAVOUR OF METABO.

With Metabo you always make a good decision. Since productivity is the sum of safety, robustness and service, it plays a central role for us - just as it does for you, your employees and the efficiency of your company. In a nutshell: With Metabo you are always on the safe side.



Ultimate productivity

We know that power tools in industrial use are expected to deliver high productivity. Therefore, the delivery of highest productivity applies to all system solutions from Metabo - we want you to save time and money when using our products.



Comprehensive Service

Our customer service on site ensures that you can test and procure the right machine for your application from the start. In case of any defects or wear and tear, the uniquely fast spare part and repair service helps to minimise unnecessary downtime so that you can resume work in a quick and uncomplicated fashion.



Maximum safety

Safety in the workplace is one of the most dominant topics in industrial environments. Our machines basically fulfil the highest requirements in terms of health and safety and thus ensure, amongst other considerations, longer run times and less work related illness.



Durable Robustness

Apart from safety and service, the robustness and connected durability of a power tool plays a major part in productivity. Thanks to our close customer proximity, major factors for maximum robustness in industrial surroundings are already implemented into the product development in Nürtingen. The result: Metabo has a considerably longer service life!



PERFORMANCE WITHOUT LIMITS.

Productivity means for us: maximum performance with best results and with lowest cost. This translates for you into: the optimal combination of robustness, safety and service. Components such as the Metabo Marathon motor in our 1,700 Watt compact angle grinder or special products, like our flat-head angle grinder, show above-average performance, highest reliability and durability - three factors ensuring more efficiency and high productivity.

Problem solver: The flat-head angle grinder

Thanks to patented flat gear design, it's an innovative solution for significantly more productivity in shallow angles down to 39°!

More power, more performance, longer service life: the Marathon motor.

Solidly made from the best components "Made in Nürtingen". For top performance you can rely on.



Full operation even in hard to reach places: Our cordless flat head angle grinder is ideal when dressing weld seams.

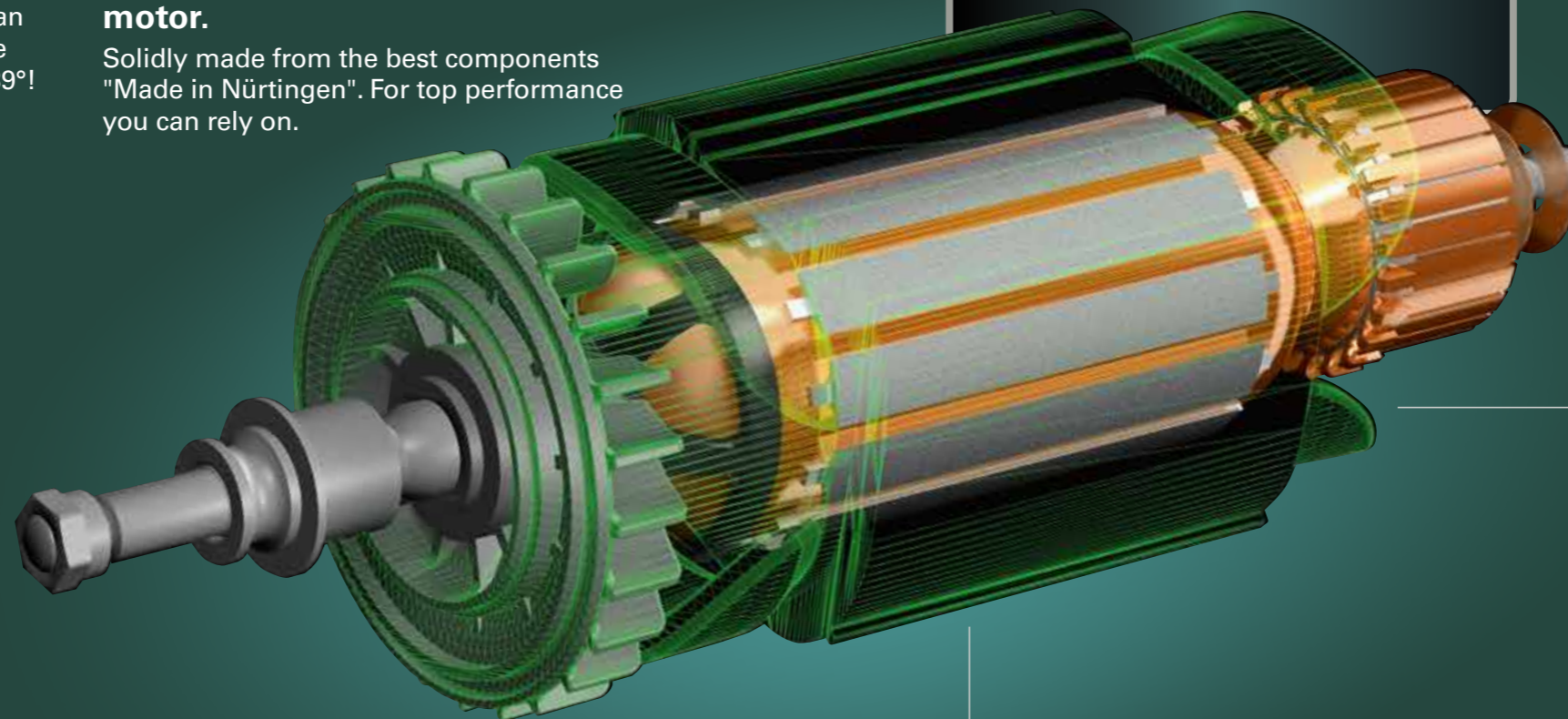

Made for major tasks: the Metabo angle grinder with Marathon motor in continuous use in container construction.

Longer service life thanks to 30% more resin to protect against abrasion and flow optimised dust protection basket

*Compared to relevant competitors. Measured using the K36 ceramic disc at a power consumption of 10 A/2,300 W.

The performance proof: Comparison to the competition in the 1,700 Watt class

20% higher overload capacity thanks to high speed cooling!

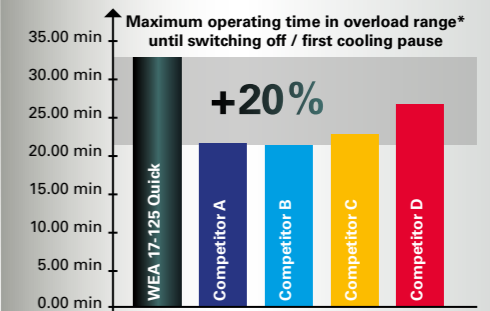

Up to 50% more torque thanks to larger rotor diameter!

Constant speeds under load for unique productivity.

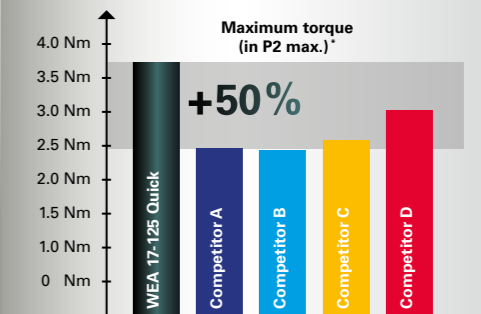

20% more output power thanks to new field technology!

Letting you reach your goal faster.

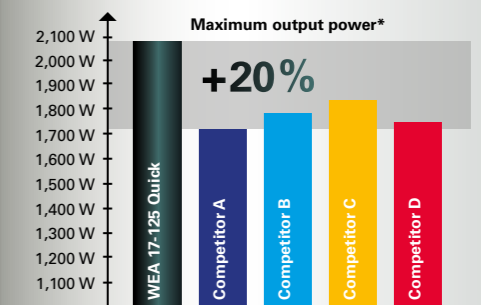

PRODUCTIVITY

Your benefits

- Reduce your production costs:
 - quick work progress
 - longer application times
 - lower work related illness
 - motivated employees thanks to easier working
 - improved process safety

USER PROTECTION COMES FIRST.

The harder the job, the more important it is to protect Metabo users to the highest degree possible. Our products for industrial use fulfill even the strictest safety standards and vibration limits (HAV). Innovative, partially patented safety systems protect against accidents, keep employees away from dangerous symptoms of fatigue or illness, and thus reduce the downtime risk.

Metabo S-automatic Torque Limiting Clutch

Direct mechanical decoupling of the drive (anti-kickback) ensures reduced kickback when the disc stops unexpectedly and permits direct continuation of your work. Furthermore, the dangerous potential for bursting the cutting disc is also prevented.

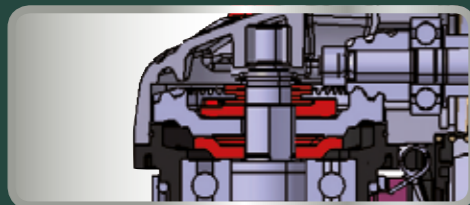

Patented Metabo disc brake:

Fastest brake system for highest user protection and, thanks to restart protection, the only system with 100% efficiency even in the event of a power cut.

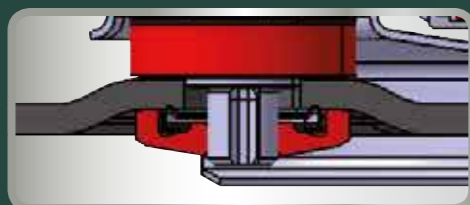

More information can be found at www.metabo.com

Only rear-facing ventilation ports
not possible to inadvertently block during normal use thus ensuring exemplary service life. Even under extreme conditions it still offers a new level of performance

Perfect ergonomics:
tangibly lower weight and reduced handle circumference for low-fatigue operation

New Metabo Marathon motor:
up to 50% more torque, up to 20% more maximum output power and up to 20% more overload capacity compared to the relevant competitors



WEPBA 17-125 Quick



Further safety systems:

The Protect safety switch (dead man switch) ensures immediate shutdown of the machine when the switch is released and also provides safety shut off capability in case of a temporary power cut.



Integrated Auto-balancer:

50% less hand-arm vibration ensures low-fatigue working and protects from symptoms of related illnesses; Metabo has the only angle grinder that significantly undercuts the vibration threshold (5m/s²).

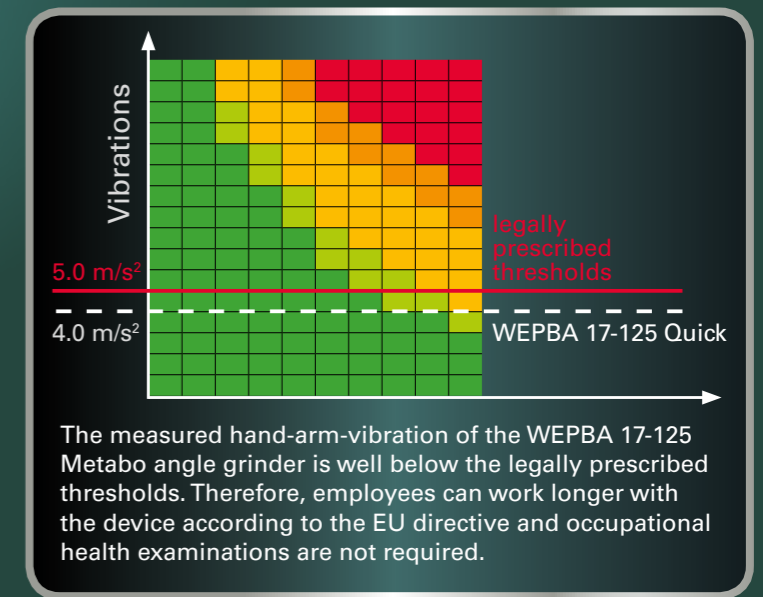

The measured hand-arm-vibration of the WEPBA 17-125 Metabo angle grinder is well below the legally prescribed thresholds. Therefore, employees can work longer with the device according to the EU directive and occupational health examinations are not required.



SAFETY

Your benefits

- More safety in everyday use:
 - significant reduction in occupational accidents
 - clearly meets (exceeds) the EU directives
 - lower costs thanks to reduced sick rate
 - occupational health examinations are not required

LONG SERVICE LIFE GUARANTEED.

Our experience works for you: The long service life of our machines and of our accessories reduce the need for new investments and secures the reliability of your work flows and work processes. This saves valuable time, increases efficiency in your company and significantly reduces your cost. Examples are:

Our LiHD battery packs for continuously high performance.

The combination of new high-performance cells and the completely new developed components ensure 67% more power*, 87% longer run time** and 100% longer service life***. This makes applications in industrial everyday life possible even under the harshest conditions. Metabo grants a 3 year warranty on all Li-Ion and LiHD battery packs.



Our new Metabo Marathon motor for power, endurance and long service life.

The patented Metabo Marathon motor continuously sets new standards in terms of overload capacity. The special epoxy resin powder coating on the field coil and the coil guard provides additional protection making it particularly resistant to dusts - and thus ensures an even longer service life for the machine.

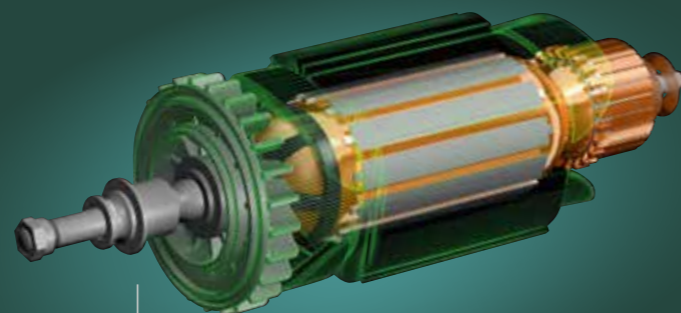

Our extremely robust and stable housings and gears.

The aluminium die-cast gear housings and metal precision planetary gears developed and produced in Nürtingen, ensure optimum heat dissipation and maximum stability. Metabo attaches greatest importance to

quality and every machine has to pass through numerous test stations. After all, "Made in Germany" is always a promise of quality to us. We are happy to prove this - please test it yourself.



* Cordless angle grinder cutting speed comparison in mm per battery charge: LiHD vs. Li-Ion 5.2 Ah. Material: sheet steel, 6 mm
 ** Cordless angle grinder cutting length comparison in mm per battery charge: LiHD vs. Li-Ion 5.2 Ah. Material: sheet steel, 6 mm
 *** 100 % longer service life (= double number of charging cycles) thanks to less frequent charging as a result of the increased amount of useful energy and significantly less heat generation to protect the cells



ROBUSTNESS

Your benefits

- Bank on safer investments:**
- Metabo machines reduce the frequency of new purchases and ensure cost savings.
 - Metabo quality ensures high process safety and less downtime costs.
 - Metabo system solutions meet industrial standards in every respect.

ALWAYS READY TO GO.

Power tools and accessories for industrial applications only deliver the desired results if they are part of an integrated overall solution. This is why we are offering comprehensive services perfectly adapted to your individual requirements. Even if you have very particular requirements, we will find a way, in an uncomplicated, flexible, reliable and fast manner.

Extensive application analysis

To begin with, your applications or tasks are analysed by our technicians on site. We will gladly advise you together with our local trade partners - with the aim to increase your productivity.



Metabo application analysis on site

Tools and accessories for testing

Would you like to put our tools to the test yourself? We would be pleased to provide a test package of power tools and accessories, designed to your requirements.



Metabo test package on site

Training on site

Our customer services on site also include for example, vibration measurements, and also training your employees on such topics as "Safety tips to prevent occupational accidents", "Treatment of stainless steel surfaces" and "Repairs".

Individual product and service solutions

No matter if individual adaptations are required for the device or bespoke customised services, almost anything can be realised amongst our partners - talk to us.



3 year XXL warranty



We give you an extra XXL warranty on all our products. Simply register your product online within four weeks of purchase and your standard guarantee is extended to three years.

Online services



At www.metabo.com you will find everything you need to know about Metabo products and services.

8 years component availability guarantee



We guarantee you an 8 year availability of spare parts even after phased out production.

Product and application advice



Should you have any questions regarding Metabo products, our qualified staff are at your disposal at any time.



SERVICE

Your benefits

Profit from individual solutions:

- direct support from Metabo's local or appointed partner
- reduced downtimes thanks to extensive service solutions
- Pre and after sales services from a single source
- on request, preventive checks on user safety

LiHD BATTERY PACK TECHNOLOGY: A QUANTUM LEAP IN TERMS OF PERFORMANCE.

With the innovative Metabo LiHD battery packs we now start a technological revolution: The run time could be increased by 87%, the performance by up to 67% and the service life doubled! This also makes applications in industrial surroundings, which were previously reserved exclusively to mains-powered machines, now possible with cordless solutions. And better still: All Metabo LiHD packs are 100% compatible with the current Li-ion range.

LiHD - safe investments thanks to new high performance.

The combination of innovative high-performance battery cells and completely newly developed components within the battery pack, ensures maximum power availability over an extremely long run time: Metabo has perfected this revolutionary battery pack technology to its pinnacle.

The ambitious goal of our endeavours is a totally cordless construction site and workshop. This translates for you into a maximum degree of freedom when drilling and screwdriving, cutting and grinding as well as during sawing applications. With Metabo you are on the safe side even tomorrow.

**67%
MORE
POWER**

**87%
MORE
RUNTIME**

**100%
MORE
SERVICE LIFE**

LiHD[®]
TECHNOLOGY



The extensive
Metabo 18V range

Unlimited flexibility.



Unlimited flexibility.
Select only what you need
and save money!



100% compatibility
with all Metabo cordless
machines yesterday,
today and in the future.



Ultra-M Technology
Perfect interaction
between machine, battery
pack and charger.



**3 Years
warranty**
LI-POWER / LIHD
**3 year battery pack
warranty**
3 years on all Li-Ion
and LiHD battery packs.

THE PRODUCTIVITY TURBO: OUR CONSUMABLES AND SYSTEM ACCESSORIES.

As a system provider we support the performance power of our tools with an optimally coordinated range of system accessories and consumables. Only this way will you achieve the productivity, long service life and reliability that you rightly expect from a Metabo machine.



Your benefits

With Metabo consumables and system accessories you can:

- optimally use the performance and efficiency of the Metabo machines.
- bank on highest quality, durability and reliability.
- be sure that it has proven itself extremely well in hardest industrial use.

MADE IN GERMANY: INNOVATION IS OUR TRADITION.

Since 1924, here in our plant in Nürtingen, we have been developing ideas, pioneering power tools and perfecting coordinated accessories for professional industrial users. When it matters: Talk to us about your requirements, tasks and wishes. We are looking forward to receiving your feedback!

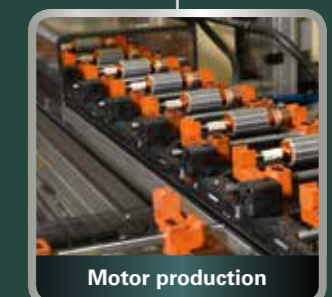
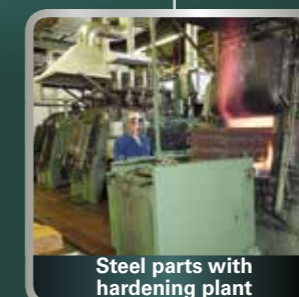

Metabo - always close by.

With 1,800 employees, 25 subsidiary sales companies and 100 importers on all continents, we have a global presence on site - and always there whenever and wherever you need us.



Your Metabo dealer:

XXL
3 YEARS
WARRANTY

The Metabo 3-year warranty

We provide an extra XXL warranty on all our products. Simply register your product online within 4 weeks of purchase and your standard guarantee is extended to three years.

Register at www.metabo.com/xxl

Metabowerke GmbH
Metabo-Allee 1 • 72622 Nürtingen
www.metabo.com



metabo®

PROFESSIONAL POWER TOOL SOLUTIONS